

# INSTRUCTION MANUAL FOR THE CAMBO MASTER AND LEGEND SERIES VIEW CAMERAS

## INTRODUCTION

Welcome to the Cambo large format family! Your new Cambo view camera is built to give you maximum performance and precision results for years to come. To take advantage of your cameras many sophisticated features, study this instruction manual and keep it as handy reference.

This manual offers instructions for both the Cambo Legend and Master Series cameras including the Legend, Legend plus (or Legend PC), Master and Master plus (or Master PC). Many features are common in all these cameras, such as the monorail system. Features that differ from camera to camera are explained in detail.

## INTRODUCTION

Bienvenue dans la famille grand format CAMBO. La nouvelle chambre CAMBO est faite pour vous procurer des performances inégalées et d'excellents résultats pendant des années. Afin de profiter de tous les avantages de votre chambre, étudiez cette brochure attentivement et conservez-la.

Ce manuel correspond aux séries CAMBO Legend et Master y compris la Legend Plus (ou Legend PC) Master et Master Plus (ou Master PC). De nombreuses caractéristiques sont communes, tel le même système monorail. Les caractéristiques qui diffèrent d'une chambre à l'autre sont expliquées en détail.

## EINLEITUNG

Wir begrüßen Sie herzlichst als neuer Cambo Großformat-Kamera-Besitzer! Ihre neue Cambo Kamera gewährleistet Ihnen maximale Leistung, gekoppelt mit Präzisionsergebnissen über viele Jahre hinweg. Damit Sie den vollen Nutzen der vielen vorzüglichen Vorteile ihrer Cambo Kamera ziehen können, sollten Sie diese Bedienungsanleitung aufmerksam lesen und für spätere Referenz aufbewahren.

Diese Anleitung umfaßt die Master und Legend Kamera Serien.

Beide Serien haben viele Eigenschaften gemeinsam, wie z.B. das Bankrohr-System. Auf unterschiedliche Eigenschaften der Master und Legend Kameras wird detailliert hingewiesen.

## INTRODUCTIE

Gefeliciteerd met uw aankoop van een Cambo Camera!

Uw nieuwe Cambo technische camera is erop gebouwd, om u optimale prestaties en verfijnde resultaten voor vele jaren te bieden.

Om de vele uitstekende mogelijkheden van uw camera volledig te kunnen benutten, wordt u geadviseerd deze handleiding te bestuderen, en bij de hand te houden als naslagwerk.

Deze handleiding biedt instructies voor zowel de Cambo Legend als de Cambo Master types, waartoe Basis- en Plus-uitvoeringen behoren. Veel toepassingen zijn identiek op alle camera's van dit systeem, zoals het monorail principe. Voorzieningen die verschillen van camera tot camera worden apart behandeld.

## II. LIST OF FUNCTIONS

1. Mounting block locking knob
2. Fine focusing knob
3. Depth-of-field calculator
4. Fine focusing locking lever
5. Quick focusing locking lever
6. Base tilt locking lever
7. Geared lateral shift knob
8. Lateral shift locking lever\*
9. Ground glass Retaining clips incl. Fresnel lens tangs
10. Retaining clips
11. Bail release handle
12. Ground glass frame removal clips
13. Slide lock for viewing hoods
14. Slide lock for bellows, lensboard and back
15. Rotating back locking lever
16. Spirit levels
17. Tilt locking knob
18. Geared tilt knob
19. Rise and fall locking knob
20. Geared rise and fall knob
21. Swing locking knob
22. Geared swing knob
23. Swing locking lever
24. Removable end-cap of monorail
25. Variable tilt axis-scale
26. Ground glass scale for tilt
27. Ground glass scale for swing
28. Variable swing axis-scale

All locking levers and locking knobs lock by turning clockwise, and release by turning counter-clockwise.

\* Lever #8 will also release when using Knob #7



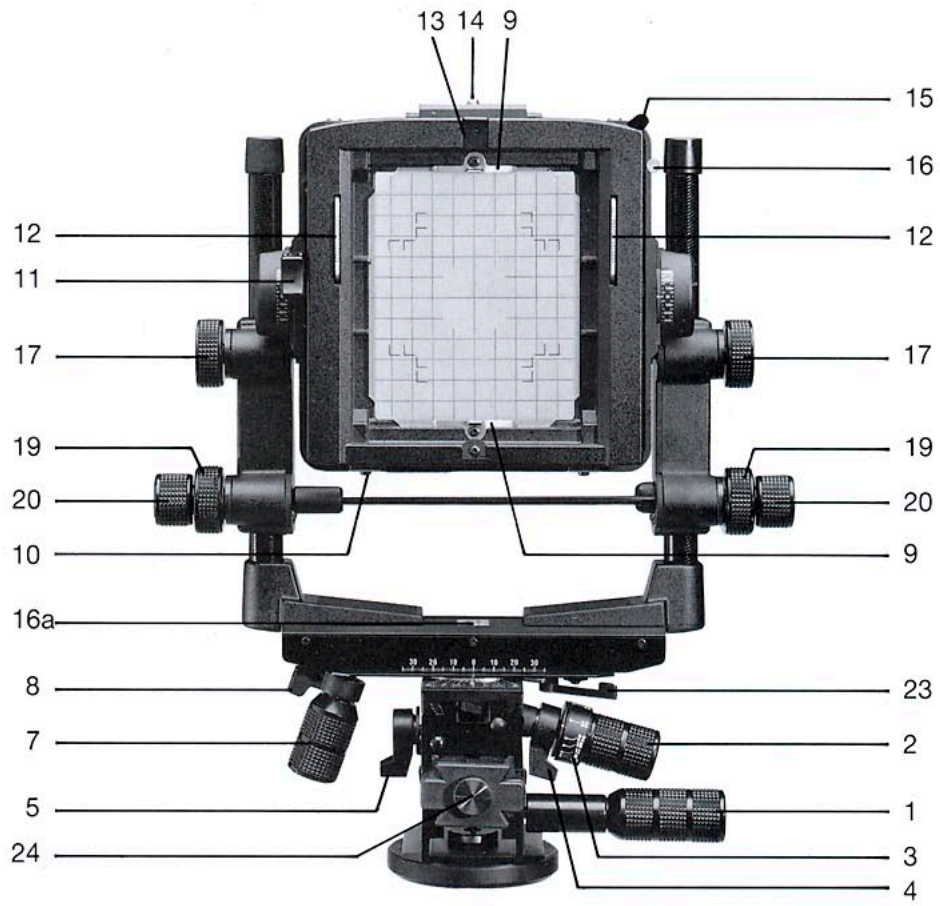

Fig. 1



Fig. 2



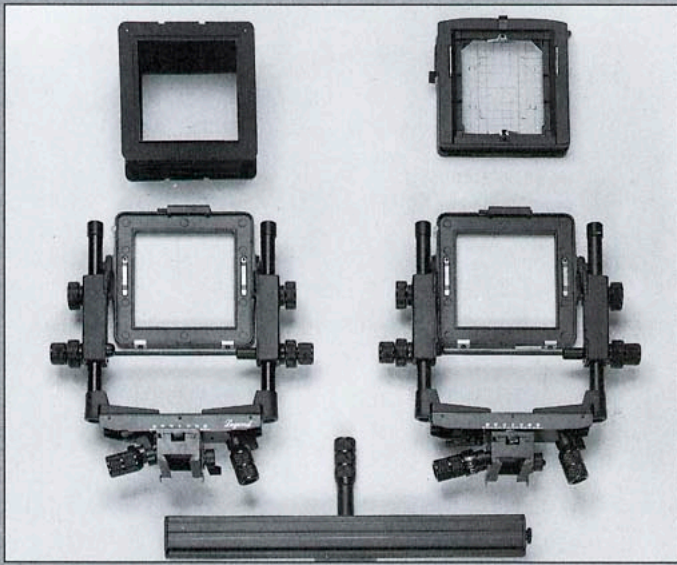

Fig. 3



Fig. 4

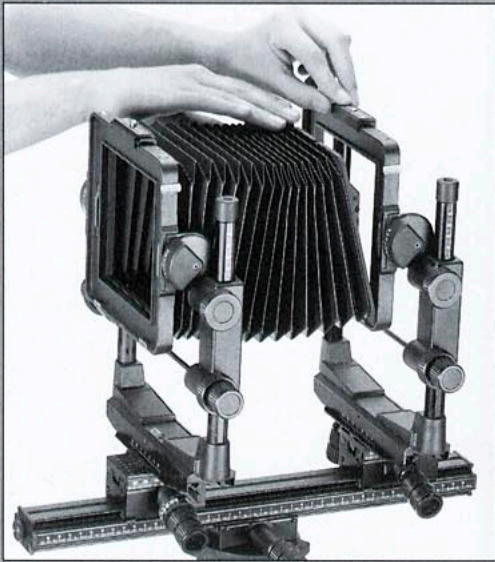

Fig. 7

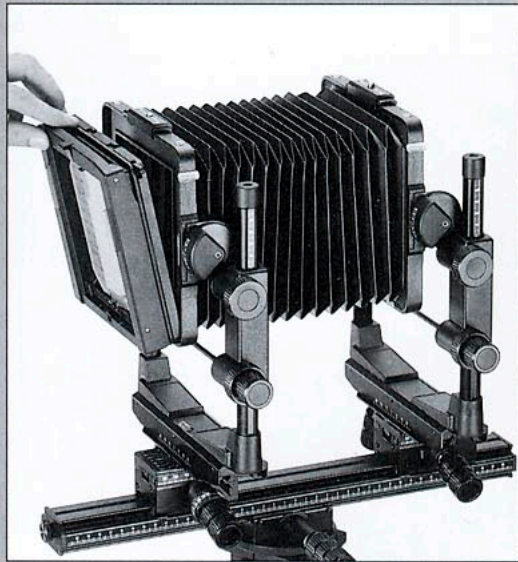

Fig. 8

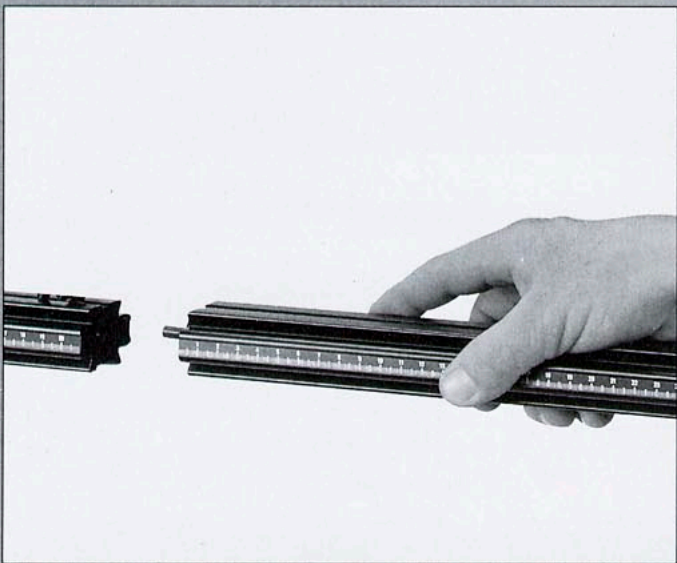

Fig. 11

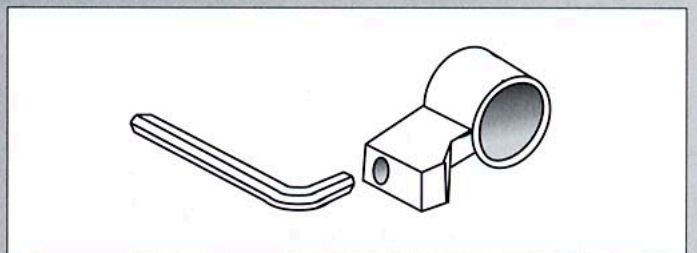

Fig. 12

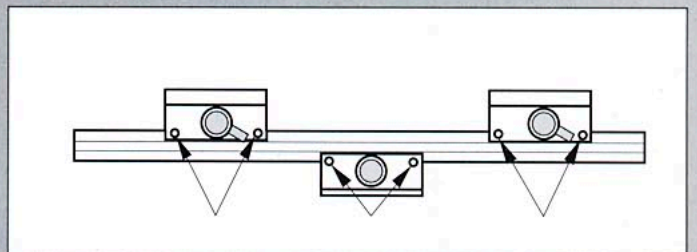

Fig. 13



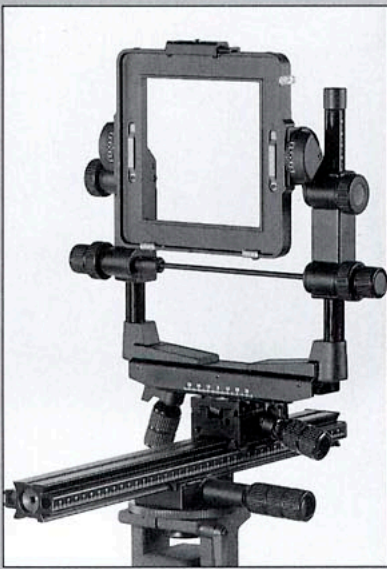

Fig. 5

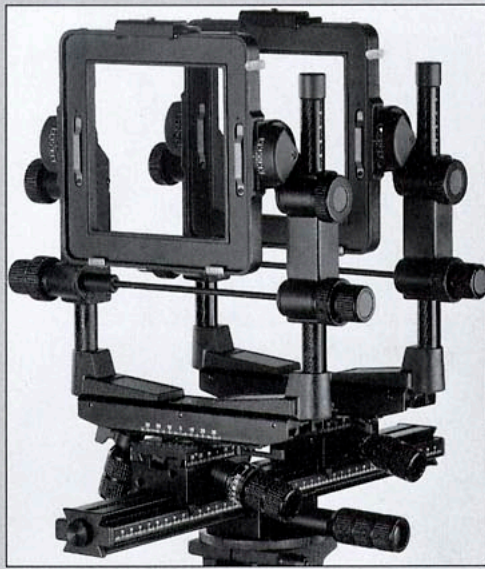

Fig. 6

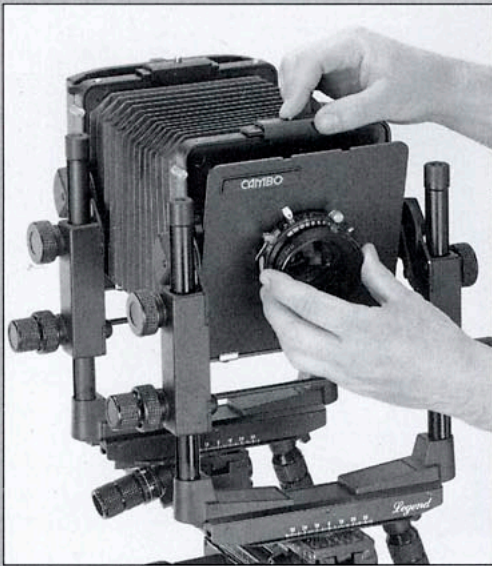

Fig. 9

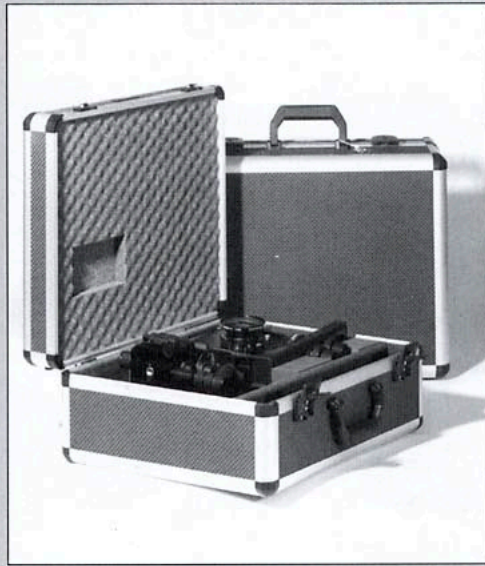

Fig. 10

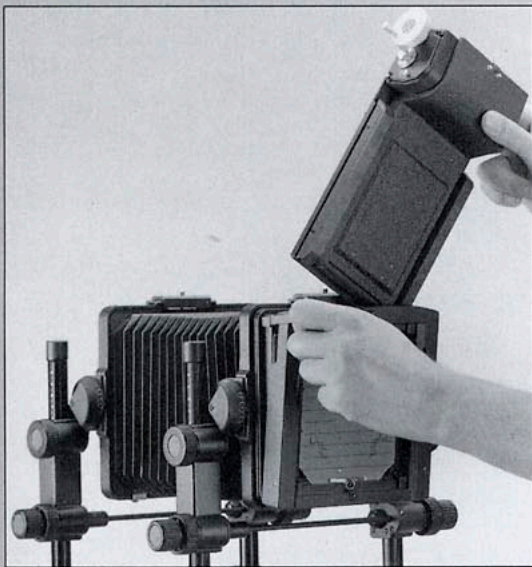

Fig. 14

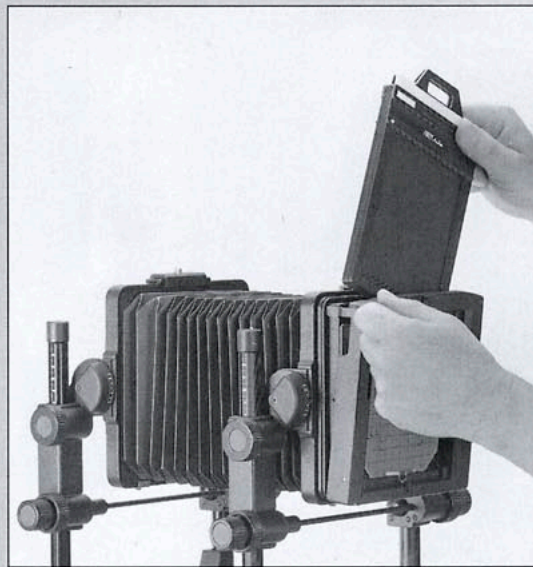

Fig. 15



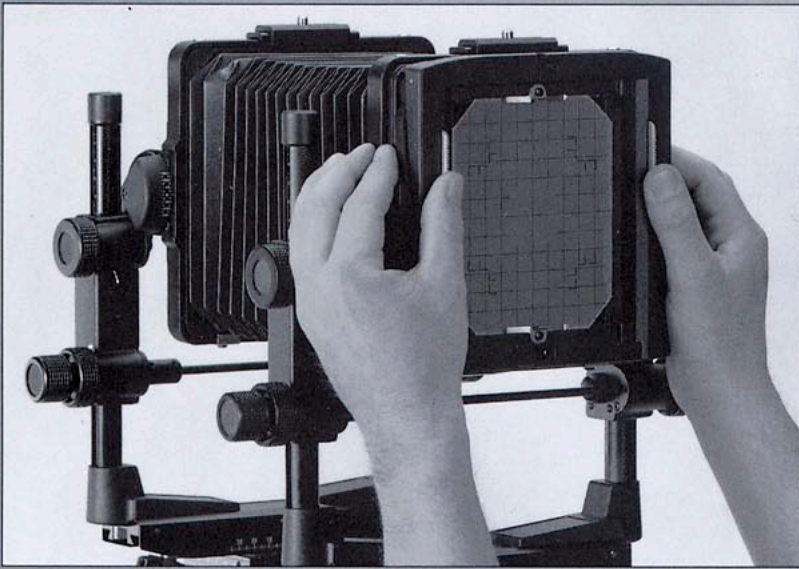

Fig. 16

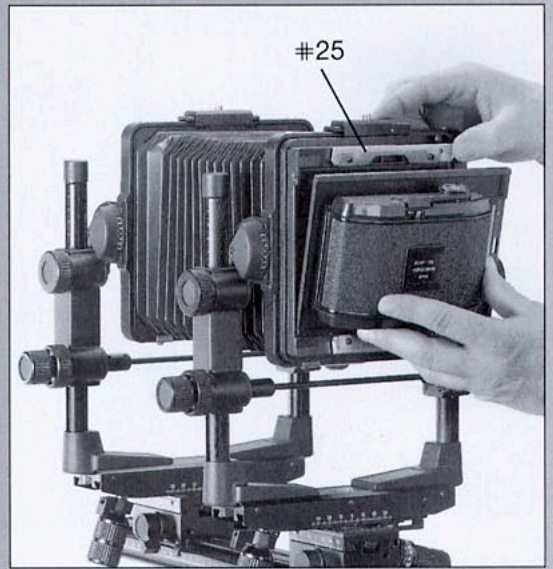

Fig. 17



Fig. 18

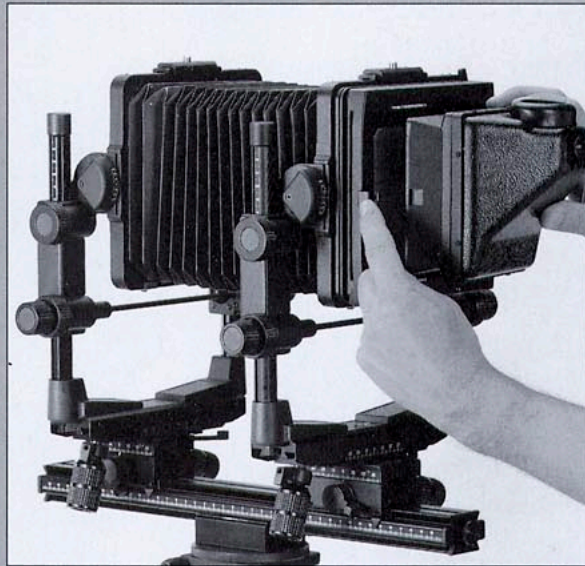

Fig. 19

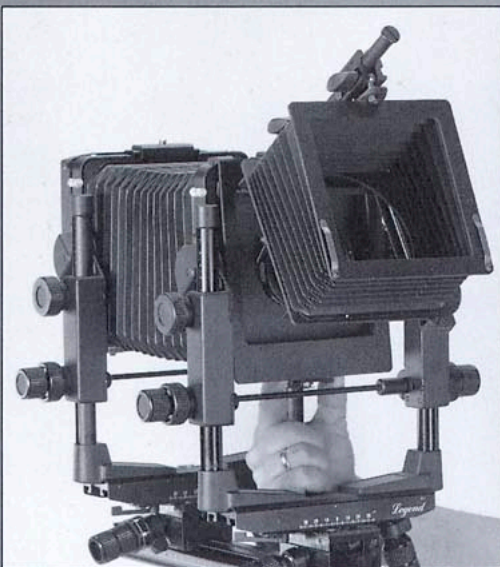

Fig. 20

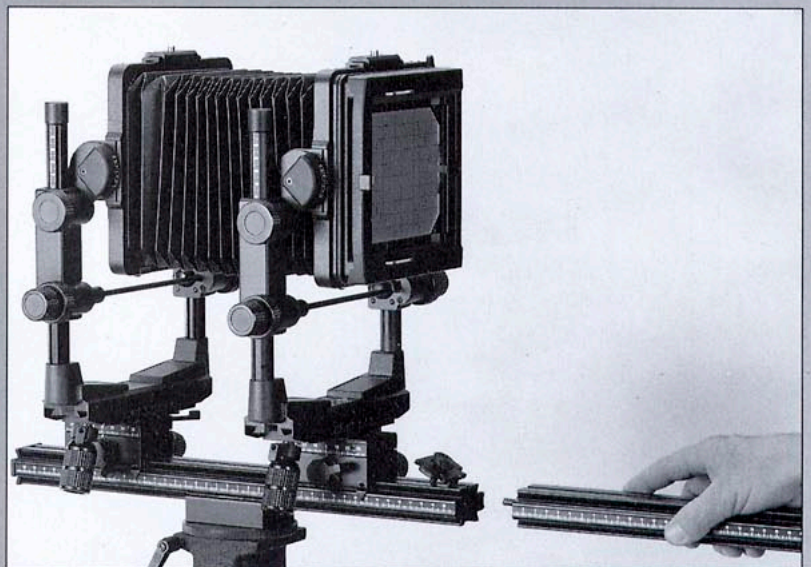

Fig. 21



# III. ASSEMBLING YOUR MASTER, LEGEND, LEGEND PLUS (PC) CAMERA

## NOTE:

All 'right' and 'left' references assume you are standing behind the camera.

- A.** Remove all camera parts from the carton. Make sure that you have one of each of the following: Front standard, Rear standard, Monorail with Mounting block, Bellows and Ground glass back. (see picture 3)
- B.** Mount the Monorail with Mounting block to tripod or studio stand fitted with a  $\frac{3}{8}$ " thread. Use of a  $\frac{1}{4}$ " reducing socket is not recommended. Secure tightly. Remove the Monorail's end cap (#24), which will designate the rear of the camera, by turning the knob counter-clockwise. (see picture 4)

- C.** Remove the packing material from the base of the Front standard and slide it gently onto the Monorail with the Fine Focusing Knob (#2) and the Spirit Level (#16) on the right. (see picture 5)

## NOTE:

The front standard DOES NOT have the Depth-of-Field Indicator Scale on the Fine focusing knob.

- D.** Slide the Front standard towards the front of the Monorail, lock into position and follow the same procedure with the Rear standard, with the Depth-of-Field Indicator (#3) and Fine focusing knob (#2) on the right. (see picture 6)

- E.** To attach the Bellows, position the Slide-lock (#14) on top of the Front standard to the right and the Slide-lock on top of the Rear standard to the left. This is done by depressing the button and sliding the bar with the arrows in the desired direction.

## NOTE:

The arrows indicate which side of the standard is unlocked with the bar shifted in that direction. When the slide-lock bar is in the center position, both sides of the standard are in 'lock' position.

The bellows are reversible, both front to rear, and top to bottom, but must be attached to the camera with the notches of the mounting plates

on the top and the bottom. Insert the Bellows mounting plate first into the bottom of the Front standard, behind the chrome retainer clips (#10), press the plate flat against the standard and return the Slide-lock to the center 'lock' position.

## NOTE:

It is not necessary to push the release button at this point. The Sliding-lock will automatically stop at the 'lock' position.

Repeat this procedure on the Rear standard. (see picture 7)

- F.** To install the Ground glass back, move the Rear standard Slide-lock (#14) to the right, insert the bottom of the Back behind the chrome retainer clips (#10), press the Back flat against the standard and return the Slide-lock to the center 'lock' position. (see picture 8) The Ground glass frame can be removed for specific applications such as installing 'Graf-lock' rollfilm-holders by depressing the two gripped bars (#12) and sliding the frame upwards (when back in vertical position).

## NOTE:

All Cambo 4 x 5" backs have a threaded hole for use with the Prontor Professional Shutter System.

- G.** To install the Lensboard (not included with camera), follow the same procedure as installing the Ground Glass Back. (see picture 9)

## NOTE:

Always refer to the arrows on top of the Slide-lock which indicate the side of the standard being released. It is always recommended that you hold onto the top of the standard so that your thumb and index finger safely hold the Bellows mounting plate AND Lensboard (or Ground glass back) into position until you are assured that you have released the side that you intended. This is strictly a preventative safeguard.

Additional Lensboards are available from your Cambo distributor.

- H.** If your camera has a base tilt (#6), always refer to the spirit levels (#16) to compare Front and Rear standard tilts.



## IV. INSTALLING YOUR MASTER PLUS (MASTER PC)

- A.** Your new Cambo Master Plus (Master PC) is delivered in a carrying case. For your convenience, the Master Plus is assembled and mounted to the short section of its 'Split' Monorail. You will also find the long section of the Monorail in the carrying case. (see picture 10).
- B.** Carefully remove camera from protective packing. Mount entire camera with mounting block on a stand or a tripod fitted with  $\frac{3}{8}$ " thread. Use of a  $\frac{1}{4}$ " reducing socket is not recommended. Secure tightly.
- C.** Remove the protective packing from the long Monorail section. Insert the threaded bolt of the long section, and its tapered stabilizing pin (which should be on the right side of the bolt) into the rear end of the short section and turn knob clock-wise until the two sections are securely joined. (see picture 11)
- D.** To remove or install Bellows, Ground glass back and Lensboard, refer to section III, parts E,F and G.
- E.** Your Master Plus (PC) camera has a base tilt (#6); always refer to the spirit levels (#16) to compare Front and Rear standard tilts.

### NOTE:

The long section of the Split Monorail measures 25 cm long. Replacable extensions of 42 cm or 65 cm are available from your Cambo distributor. See also section VII, part H.

### NOTE:

All Cambo 4 x 5" backs have a threaded hole for use with the Prontor Professional Shutter System.

## V. HOW TO USE THE DEPTH-OF-FIELD CALCULATOR

With this Depth-of-field Indicator, there's no more looking through a dark, stopped-down Ground-glass to 'guess' your field of focus. Your Depth-of-field is determined at maximum aperture, without stopping down your lens at all.

It's quick, easy, and -most important- accurate. Using the Depth-of-field indicator is easy. For determining maximum shooting aperture, follow these 4 steps:

1. At full aperture focus on the farthest point of a scene you wish to render sharply.
2. Set Depth-of-field scale (#3) at zero (0).
3. Next, at full aperture, focus on the nearest point of required focus. Depth-of-field scale will indicate the f/stop needed to encompass the area between the two points. Set your Lens-aperture at this f/stop.
4. Rotate Focusing knob (#2) backwards, until Depth-of-field scale indicates 2 f/stops less than your shooting aperture.

This accurate computer works with any focal length, features separate 4 x 5" and 8 x 10" scales and can be used in conjunction with swing and tilt movements.



# VI. CONTROL ADJUSTMENTS

While using your camera, you may feel the need to adjust some of the following, often-used functions.

## A. Locking levers (#4, 5, 6, 8)

If any of these levers are locking at an uncomfortable or inconvenient position, you can easily adjust the locking position in the following manner: (see picture 12)

1. Firmly lock the lever.
2. Loosen the hexagonal set screw with a 2 mm hex-screwdriver.
3. Turn the lever to the desired locking position and firmly tighten the hex set-screw with the hex screwdriver.

## B. Tripod Mounting block and Focussing blocks

Both blocks have quick-sliding capabilities for rapid repositioning and coarse focussing.

To increase or decrease the friction of this movement, do the following: (see picture 13)

1. Locate the two set-screws on one side of the Mounting or Focusing Block.
2. To increase friction, or tighten movement, turn screws clockwise. Use a 2 mm hexagonal screwdriver. Both screws must be adjusted equal distances for smooth results. Adjustments should be made in  $\frac{1}{6}$  turns (60 degrees) increments and then be tested for the desired results.
3. To decrease friction, or loosen movement, turn screws counter-clockwise.

## C. Ground Glass Replacement

If your Ground glass breaks, replace the new glass by removing the Ground glass retainer clips (#9) with a screwdriver. Install the new glass with the dull side towards the inside of the camera. If necessary, you can increase the tension of the retainer clips by bending the tips inward, or towards the glass, before reinstalling. Replace the clips.

# VII. INSERTING FILMHOLDERS AND MOUNTING ACCESSORIES

Cambo cameras are designed for your convenience, offering the easiest possible operation and the maximum amount of versatility. The following instructions ensure the safest possible filmloading procedure and the proper installation of popular accessories.

## A. Inserting Sheet Film Holders, Polaroid Film Holders and Slide-in Rollfilm Holders.

(see picture 14 & 15)

To load the camera with any of these 'slide-in' filmholders, a convenient Bail Release Handle (#11) is provided to release the tension on the Ground Glass Frame, thus reducing the chance of accidental camera movement.

1. Pull out on Bail Release Handle until it locks into open position.
2. Slide loaded film holder between back and frame until it seats against end stop of back.
3. Close Bail Release Handle until frame rests against film holder.
4. When removing filmholder, pull out Bail

Release, and, when holder is out of the camera, manually return Release to original (closed) position.

DO NOT let Ground Glass Frame 'snap' back to closed position.

## B. Installing 'Graflock' or International Roll Film Holders. (see picture 16 & 17)

1. Remove the Ground Glass Frame by depressing the two gripped Bars (#12) on either side of the frame, and sliding the frame up (if frame is in vertical position), until it releases.
2. Place the Roll Film Holder against the frame, and lock it into position by pushing the two Locking Bars (#25) down into the lock position.
3. After using the Roll Film Holder, reinstall Ground Glass Frame by placing it against the back, and position the frame's hooks into the recessed slots on the right and left (if back is in vertical position). Depress the



Gripped Bars (#12) and slide the Ground Glass Frame down.

NOTE:

On 5 × 7" and 8 × 10" models, Ground Glass Frames cannot be removed.

### C. Rotating the Ground Glass Back. (see picture 18)

1. The Legend and Legend plus (pc) 4 × 5" models feature built-in revolving Ground Glass Backs. Simply release the lever (#15) and rotate the back to the desired position. The back rotates 360° and can be locked in any position. However, in an off-center or diagonal position, care should be taken to avoid image fall-off.
2. On the Master and Master Plus (pc), and the 5 × 7" and 8 × 10" models, the Ground Glass Back must be removed, then rotated manually. Hold the back with your thumb and index finger while you depress the button on the Sliding Bar (#14), and shift the bar to the right. Remove the Back, turn it to the right, and replace the back onto the standard. To lock the Back, push the Sliding Bar to the center position.

NOTE:

8 × 10" Rear standard's Slide Lock (#14) has a reversed left/right handling. Watch the indication arrows!

### D. Installing Viewing Hoods (see picture 19)

To install any viewing hood, pull up the Tab (#13) on top of the Ground Glass Back. Position the viewing hood against the Back, under the small lip at opposite side of the Tab, and push the Tab down to secure the hood in place. On 5 × 7" and 8 × 10" models the use of a Focusing Cloth is recommended.

Also Magnifiers are available from your Cambo distributor.

### E. Installing Focusing Screens, Fresnel Lenses.

1. The Ground Glass on your Cambo camera can be replaced with an unlined ground glass, or bright focusing screens. To remove the ground glass, unscrew the Retainer Clips (#9) and lift out the Ground Glass. Place the new Glass or Screen with the frosted side in towards the camera, and replace the retainer clips.
2. A Fresnel Lens, which is smaller than your Ground Glass, fits over the Ground Glass. To install the Fresnel Lens, hold it with the smooth side facing you and the etched side towards the Ground Glass. Simply press the Lens against the Ground Glass, so that the

tension of the two Retaining Tangs (#9) hold the Fresnel Lens firmly in place. If the Retaining Tangs do not hold the Fresnel Lens securely, bend the Tangs outward.

NOTE:

The Fresnel Lens fits between the Retaining Tangs, not behind these.

### F. Extension-Bellows/Bag Bellows and Bellows Support

1. To install a Bag Bellows for wide angle photography, or Extension Bellows for close-up work, follow the instructions described in Section III, Part E.

NOTE:

For very long extensions, you may need to connect two bellows together. A Multi-purpose Standard is available as an in-between carrier.

2. A Bellows support is already integrated into the design of the 8 × 10" Legend Models. A Bellows Support accessory is available for other Cambo view cameras.

Simply position the base of the support between the standards, hook the curved side of the base in the recessed edge of the Monorail, and snap the other side of the base onto the Monorail.

The height and angle of the Bellows Support can be adjusted by simply loosening the knurled screws, moving the Support in the desired position, then tightening the knurled screws.

### G. Compendium Lenshoods

Cambo offers a variety of Compendium Lenshoods, available with and without filter holders, and for use with different types of lenses and shutters.

To attach your compendium, insert the two steel pins into the two holes on top of the Front standard.

If you have the Luxe type Compendium (C-300 series) you must pull down on the spring-release bar at the bottom of the mounting plate, place it under the Front standard and release the bar. (see picture 20).

If you have the standard Compendium Lenshood, you simply pull down on the locking clip, slide it under the Front standard's housing and release it. Again, check to make sure it is securely attached. After using some time, the tension of the clips may possibly decrease. Just increase the tension by bending the clip inward.

### H. Rail Extensions

The Master and Legend series cameras share the same monorail system. All models, except



the Master Plus (PC) come with a single section rail which will accept Cambo's unique Rail Extensions. The Master Plus (PC) comes with a two-section, split monorail for compact storage and easy wide-angle conversion.

All monorails can be extended in length with a choice of 25, 42 or 65 cm Rail Extension. These extensions are positioned by steel posts so that you have a rigid, unobstructed, in-line connection. (see picture 21)

To connect the Rail Extension to the Legend types and Master camera, remove the monorail Cover Plate (#24) at the rear of the camera's monorail and screw the threaded bolt of the Rail Extension into the monorail, by turning the knob clockwise. To remove the Rail Extension, turn the knob counter-clockwise.

It is very important that you hold the Rail Extension parallel to the monorail when placing or removing it, to avoid stripping the bolts threads.

For the Master Plus (PC), move the Front and Rear standards onto the short section of the split monorail. Remove the long section of the monorail at the rear of the camera, and install the longer Rail Extension by following the above instructions.

**NOTE:**

The Master Plus (PC) does not have a monorail cover plate (#24).

Cambo also offers an Expandible Monorail, which features stepless extensions from 42 to 65 cm. When mounting the Expandible monorail on any Master or Legend series camera, the Front standard must be mounted on the short section of the rail, and the Rear standard on the long section, as has been described in Section III.

Be sure to replace the Cover plates after installing.

Rail Extensions can be added to the long section of the Expandible Monorail, as described above.

### **I. The Cambo Accessory System**

For additional information on the complete line of Cambo accessories, see our Cambo Master, Legend, and Accessories literature.

You will find a wide variety of items, ranging from Roll Film Holders to Light Metering Systems, and from Cable releases to Carrying Cases.

Ask your Cambo distributor for more information.

This Manual is prepared by Cambo with care, although no responsibility, financial or otherwise, is accepted for any consequences arising out of the use of this manual or this material.

All specifications in this manual are subject to change without notice.

## **VIII. TWO POINT FOCUSING WITH THE MASTER PLUS**

**A.** Be sure your variable tilt axis (#25) on front and rear standard are in the same position, both on-center or both off-center.

### **B. Tilt Instructions**

1. Focus on the primary tilt line of the ground glass. This primary line can be located between 0 and 40 mm off-center, and can be read on the scale of the ground glass (#26), corresponding to scale (#25).
2. Tilt the rear standard with knob (#18) until a second line in the image, which needs to be sharp is focused also.
3. Read the tilt angle, and transfer this angle to the front standard in reversed way, 12 degrees backwards on the rear standard will be 12 degrees forwards on the front standard. Tilt the rear standard back to zero with knob (#8).
4. Check focus and adjust when needed.

### **C. Swing Instructions**

1. Focus on the primary swing line of the ground glass. This line can be located between 35 mm left and 35 mm right off-center, and can be read on the scale of the ground glass (#27), corresponding to scale (#28).
2. Swing the rear standard with knob (#22) until a second vertical line in the image, which needs to be sharp is focused also.
3. Read the swing angle, and transfer this angle to the front standard in reversed way, 8 degrees clockwise on the rear standard will be 8 degrees counter-clockwise on the front standard. Swing the rear standard back to zero position with knob (#22).
4. Check focus and adjust when needed.



# VIEW CAMERA MOVEMENTS AND HOW THEY WORK

## 1. View Camera Movements

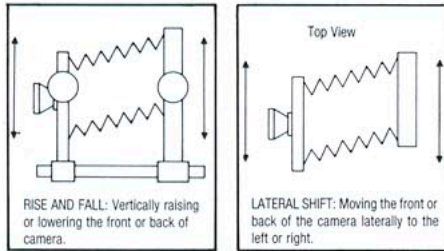
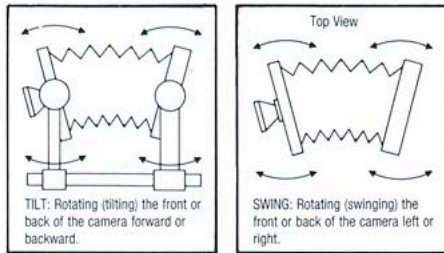

## 2. Vertical Perspective Control (Low Camera Angle)

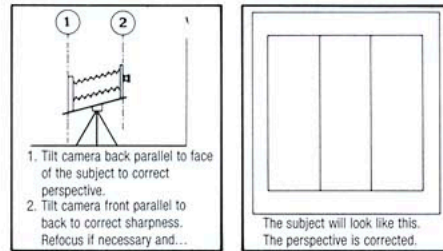
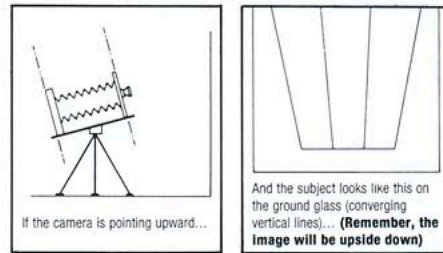

## 3. Vertical Perspective Control (High Camera Angle)

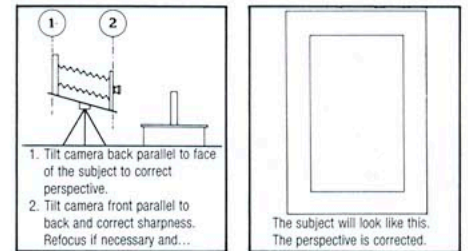
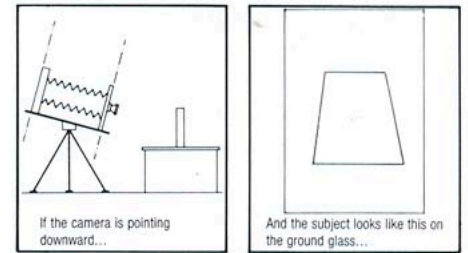

## 4. Horizontal Perspective Control

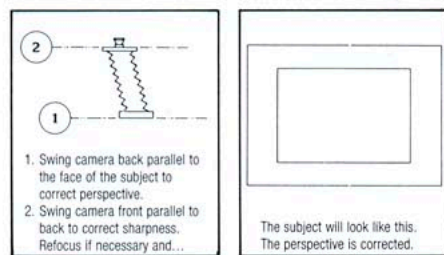
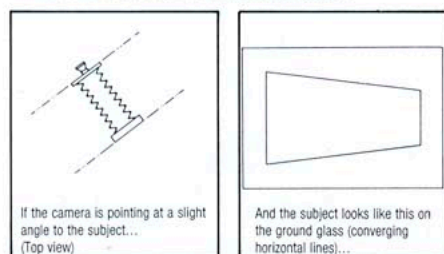

## 5. Vertical Image Placement

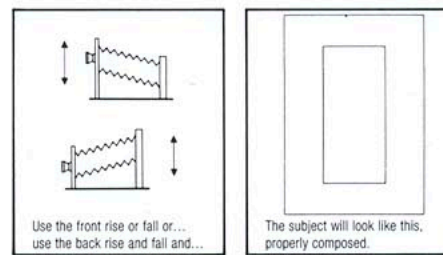
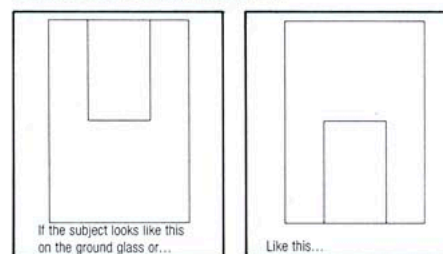

## 6. Horizontal Image Placement

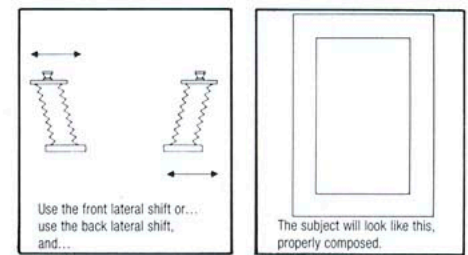
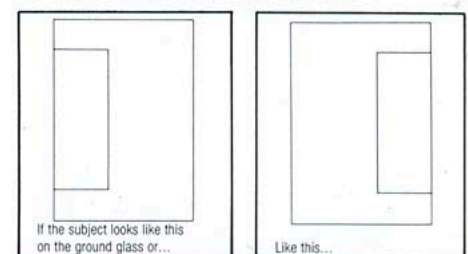

## 7. Depth Field

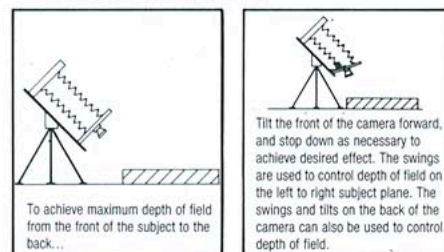

## 8. Yaw free base tilt

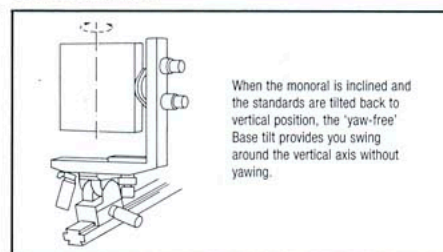

**For further information...**  
The above examples illustrate all the most commonly used view camera movements, which can be used individually or in conjunction with each other. There are many view camera books available which provide detailed discussions about camera movements.  
**Ask your Cambo distributor.**